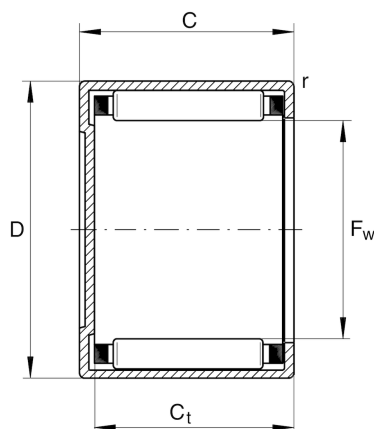
**BK0408-B**

Drawn cup needle roller bearing closed end

Schaeffler ID:
0097758110000Drawn cup needle roller bearings with
closed end BK, to DIN 618/ISO 3245

Technical information

**Main Dimensions & Performance Data**

F_w	4 mm	Under roller diameter
D	8 mm	Outside diameter
C	8 mm	Width, outer ring
C_r	1,780 N	Basic dynamic load rating, radial
C_{0r}	1,310 N	Basic static load rating, radial
C_{ur}	147 N	Fatigue load limit, radial
n_G	42,500 1/min	Limiting speed
$n_{G \text{ Grease}}$	25,500 1/min	Limiting speed for grease lubrication
n_{gr}	44,500 1/min	Reference speed
	1.6 g	Weight

Additional information

r_{\min}	0.3 mm	Minimum chamfer dimension
	GR4X8X2	Sealing ring
$C_{t \min}$	6.4 mm	Minimum width to base of drawn cup with closed end

Temperature range

T_{\min}	-30 °C	Operating temperature min.
T_{\max}	140 °C	Operating temperature max.